

CARACTERÍSTICAS TÉCNICAS

COLORES

FRONTAL



34 CASTAÑO



64 CACAO



CUERPO



67 BLANCO PASTEL

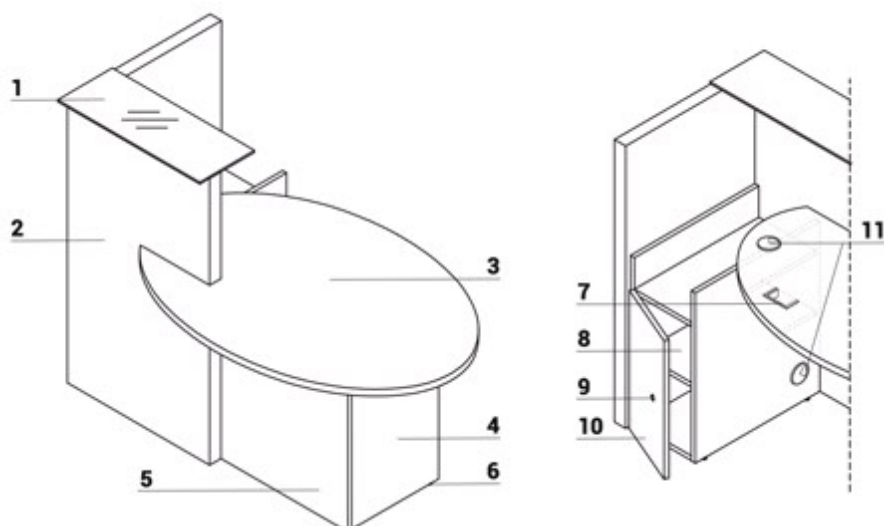

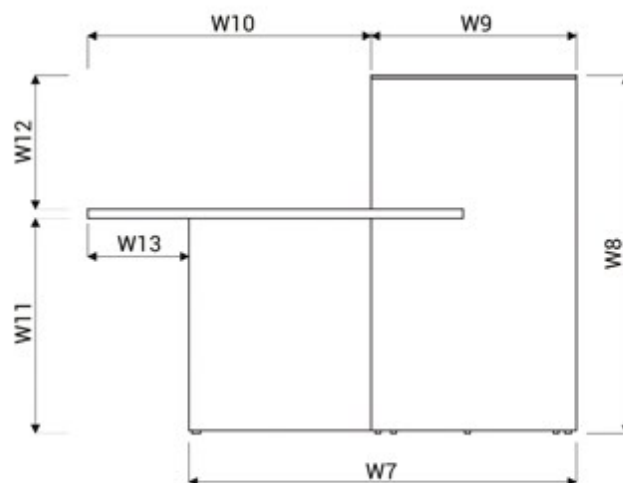
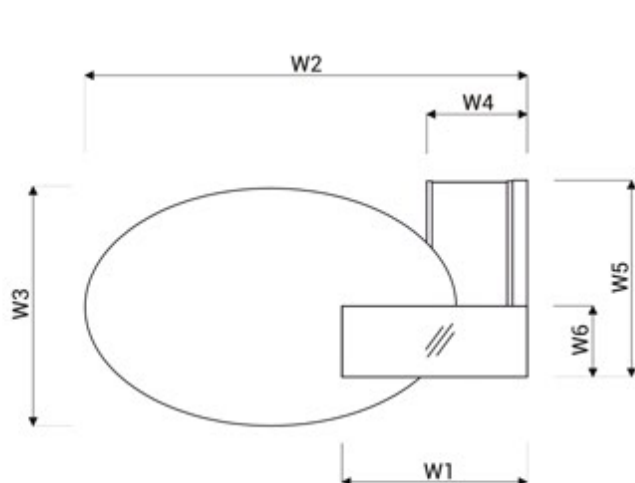

1. Encimera - Cristal al ácido templado 8mm
2. Frontal - MFC 52mm
3. Encimera - MFC 28mm, cantos PVC - con o sin rebajes pasacables
4. Cuerpo - MFC 28mm, cantos PVC
5. Cuerpo - MFC 18mm, cantos PVC
6. Nivelación - 0-5mm
7. Tapón pasacables rectangular - 90x48mm
8. Armario divisorio - MFC 18mm, cantos PVC
9. Cierre patentado
10. Frontal - MFC 18mm, cantos PVC
11. Tapones pasacables - Ø80mm

DIMENSIONES





W1 - 650mm | W2 - 1548mm | W3 - 870mm | W4 - 352mm | W5 - 695mm | W6 - 250mm | W7 - 1230mm | W8 - 1150mm | W9 - 650mm | W10 - 900mm | W11 - 692mm | W12 - 430mm | W13 - 320mm

OVO

ILUSTRACIÓN DE PRODUCTO	DIMENSIONES [mm]			REFERENCIA						COMPONENTES
	LARGO	PROFUNDIDAD	ALTURA			kg	m3	pcs		

MOSTRADOR DE RECEPCIÓN OVO

	1550	870	1150	LOP10		93.0	0.240	3		
	1550	870	1150	LOL10		93.0	0.236	3		

DESCRIPCIÓN:

 - PESO NETO

 - VOLUMEN

 - NÚMERO DE PAQUETES