

CARACTERÍSTICAS TÉCNICAS

COLORES

FRONTAL, ENCIMERA SUPERIOR, CUERPO, PATA DE APOYO EN LA UNIÓN DE ENCIMERAS NG41

67 BLANCO
PASTEL

117 BLANCO

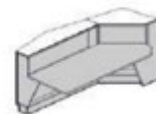

08 NEGRO

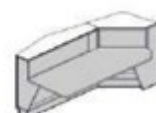

116 NEGRO

26 ALUMINIO
SATINADO

124 PLATA

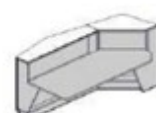
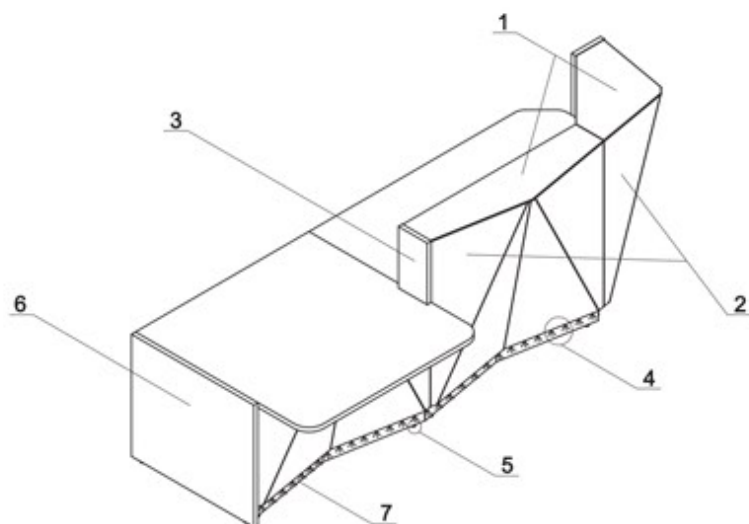
M009 ALUMINIO
SEMI-MATEM015 BLANCO
SEMI-MATEM115 NEGRO SEMI-
MATE

1. Encimera - MFC 28mm, Cristal templado 8mm
2. Frontal - MFC 12mm + cristal LACOBEL 4mm
3. Panel lateral de unión entre frentes bajos y altos - MFC 28mm, cantos PVC
4. Iluminación LED - En toda la longitud del mostrador, color blanco frío (tono azulado)
5. Nivelación - 0-5mm
6. Panel lateral bajo - MFC 28mm, cantos PVC
7. Kick plate - HPL - aluminio pulido

CARACTERÍSTICAS TÉCNICAS

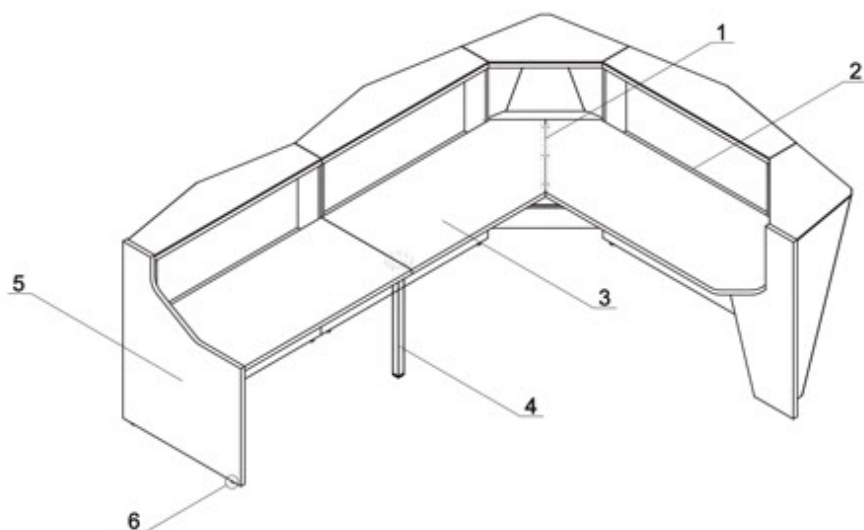

1. Barra plana de fijación
2. Bandeja del monitor - MFC 28mm
3. Encimera - MFC 28mm, cantos PVC - con o sin rebajes pasacables
4. Pata de apoyo - NG41 - acero lacado, requerida para la unión de encimeras
5. Panel lateral alto - MFC 28mm, cantos PVC
6. Nivelación - 0-5mm

APLICACIÓN ELEMENTOS FINALES

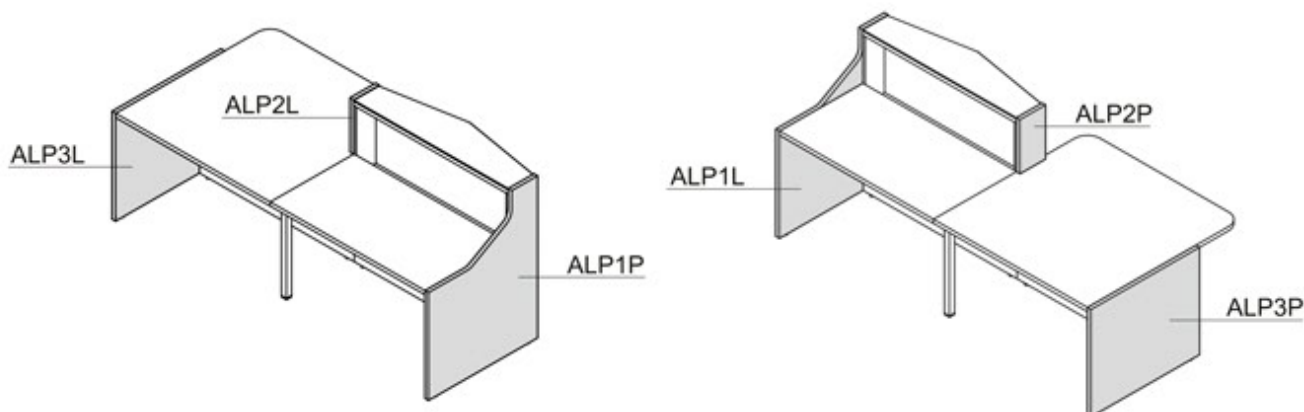



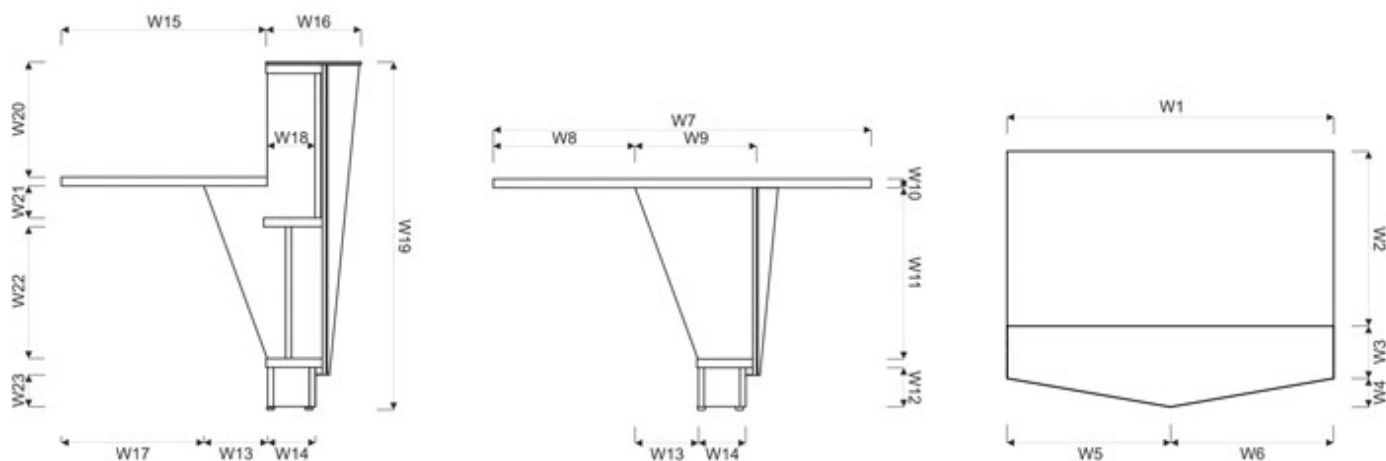

DIMENSIONES



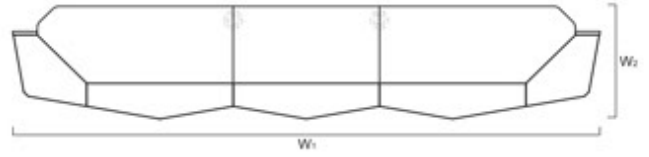
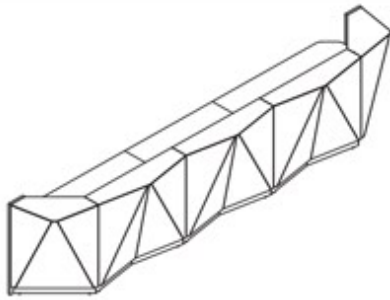



W1 - 1199mm | W2 - 650mm | W3 - 194mm | W4 - 106mm | W5 - 608mm | W6 - 608mm | W7 - 1200mm | W8 - 448mm | W9 - 353mm | W10 - 28mm | W11 - 549mm | W12 - 125mm | W13 - 199mm | W14 - 150mm | W15 - 650mm | W16 - 300mm | W17 - 449mm | W18 - 151mm | W19 - 1106mm | W20 - 366mm | W21 - 102mm | W22 - 424mm | W23 - 125mm

SISTEMAS DE MOSTRADORES DE RECEPCIÓN

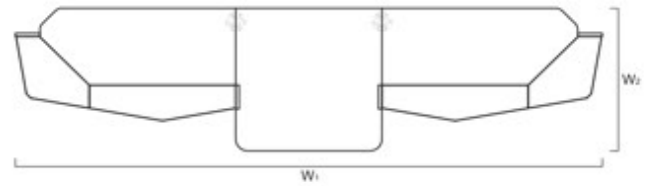
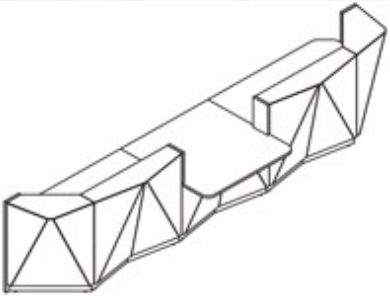

REFERENCIA	DIMENSIONES [mm]										COMPONENTES
	W ₁	W ₂	D ₁	D ₂	H						
ALP16	4813	946	-	-	1100		234.5	2.745	17		ALP18L+ALP12+ALP18P+2xNG41



REFERENCIA	DIMENSIONES [mm]										COMPONENTES
	W ₁	W ₂	D ₁	D ₂	H						
ALP25	4813	946	-	-	1100		244.5	2.530	19		ALP18L+ALP2L+ALP11+ALP2P+ALP18P+2xNG41

DESCRIPCIÓN:

 - PESO NETO

 - VOLUMEN

 - NÚMERO DE PAQUETES